

FYL-25A3UBC1B

Features:

- High intensity
- General purpose leads
- RoHs complant.

Descriptions:

- Dice material: InGaN.
- Emitting Color: Super bright Blue.
- Device Outline: 2*5mm Tombstore Type.
- Lens Type: Water clear

Radiation pattern.

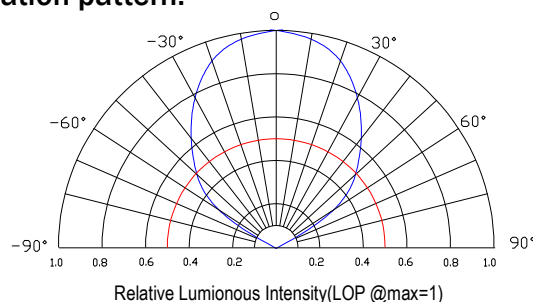

Package configuration

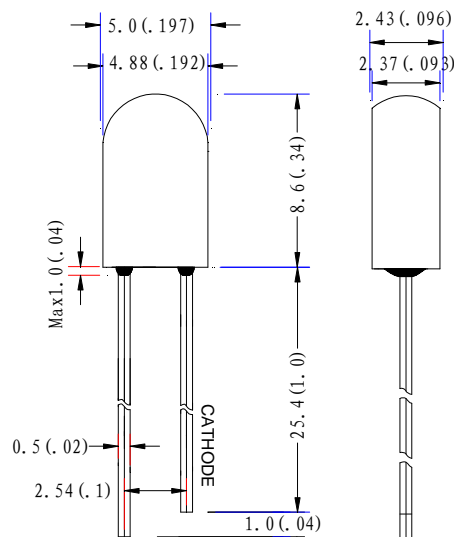

- ◆ All dimensions are millimeters (inches)
- ◆ Tolerance is $\pm 0.25\text{mm}(.010\text{'})$ unless otherwise noted.

Absolute maximum ratings($T_a=25\text{ }^\circ\text{C}$)

Parameter	MAX.	Unit
Power Dissipation	70	mW
Peak Forward Current (1/10 Duty Cycle, 0.1ms Pulse Width)	100	mA
Continuous Forward Current	20	mA
Derating Linear From 50°C	0.4	mA/°C
Reverse Voltage	5	V
Electrostatic Discharge (ESD)	150	V
Operating Temperature Range	-30°C to +80°C	
Storage Temperature Range	-40°C to +100°C	
Lead Soldering Temperature[4mm(.157") From Body]	260°C for 5 Seconds	

Electrical and optical characteristics($T_a=25\text{ }^\circ\text{C}$)

Parameter	Symbol	Min.	Typ.	Max.	Unit	Test Condition
Luminous Intensity	I_v	—	700	—	mcd	$I_F=20\text{mA}$
Viewing Angle	$2\theta_{1/2}$	90	100	110	Deg	
Peak Emission	λ_p	465	470	475	nm	
Dominant Wavelength	λ_d	460	465	470	nm	
Spectral Line Half-Width	$\Delta\lambda$	10	15	20	nm	
Forward Voltage	V_F	2.8	3.2	3.6	V	
Reverse Current	I_R			50	μA	$V_R=5\text{V}$

Typical Electrical Characteristics Curves (25 °c Ambient Temperature Unless Otherwise Noted)

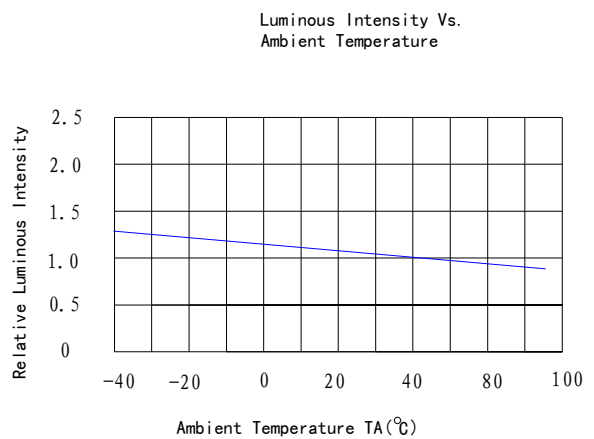
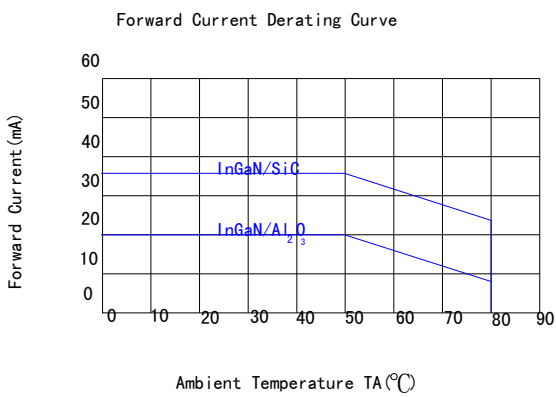
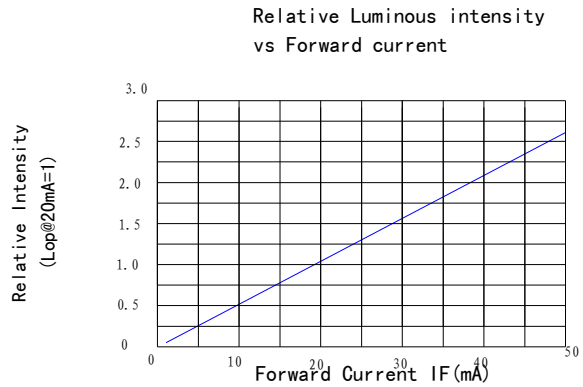
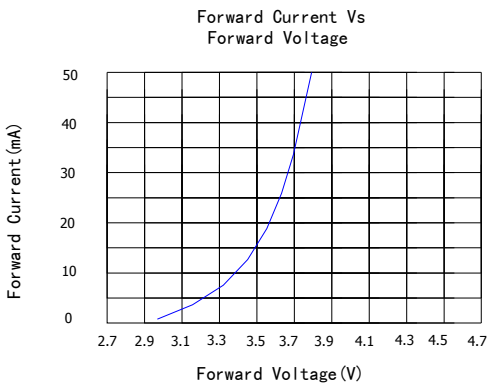
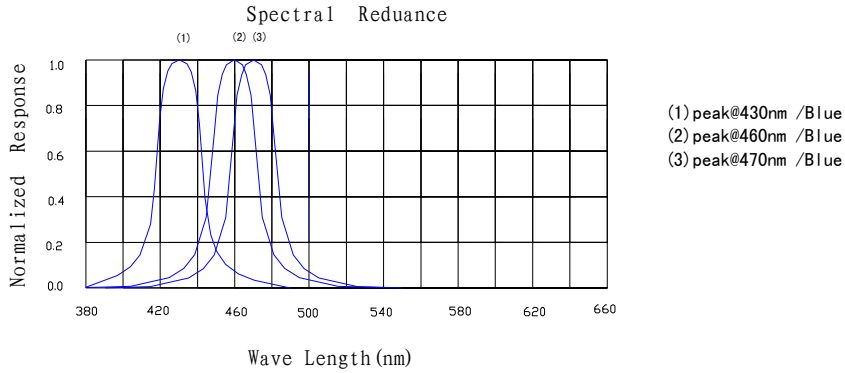

LAMP PACKING.

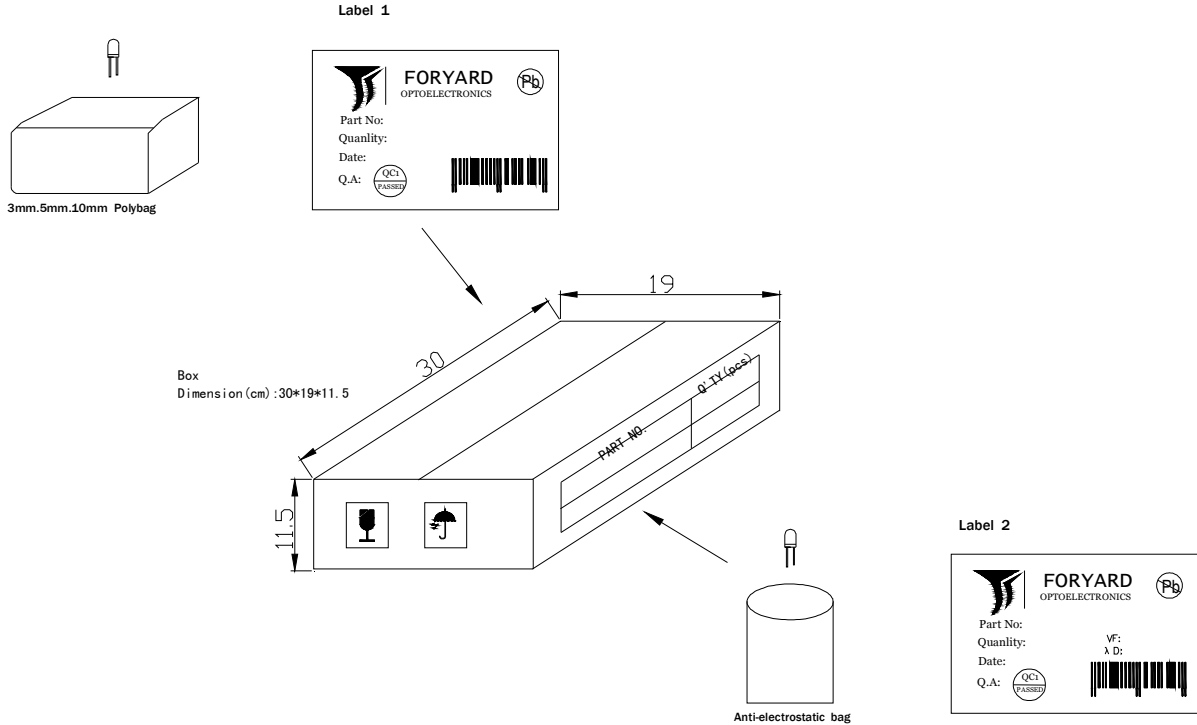

DEVICE	QTY/polybag(pcs)	Polybag/box A	Fig
5mm(T-1 3/4)	1000	8 bags	Label 1
3mm(T-1)	1000	10 bags	Label 1
10mm(T-1)	250	8 bags	Label 1
Blue/Green/White	500pcs	8 bags	Label 2

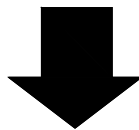

CARTON
Dimension(cm):39*32*38

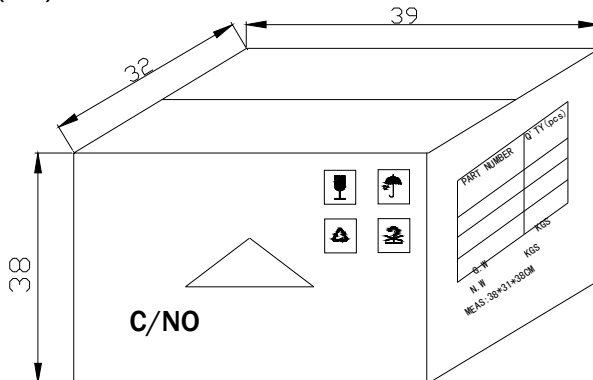

6 Boxes/Carton
5mm:48,000pcs
3mm:60,000pcs
10mm:12,000pcs
Blue/Pure Green/bluish Green
/White:24,000pcs