

FYL- 3019UEUGW1A

Features:

- High intensity
- General purpose leads
- RoHs complant.

Descriptions:

- Dice material E: GaP
G:GaP
- Emitting Color E: Red
G: Yellow Green
- Device Outline: Φ 3mm Round Type.
- Lens Type: White diffused.

Radiation pattern.

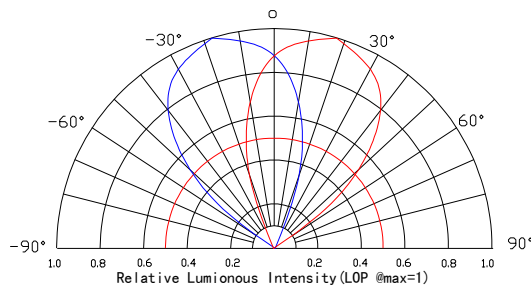

Package configuration

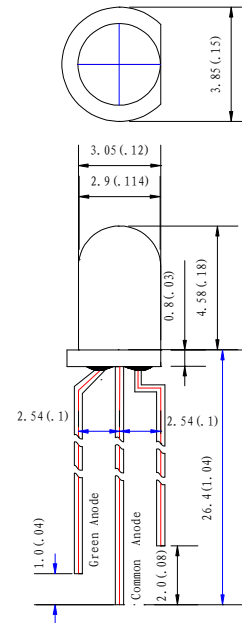

- ◆ All dimensions are millimeters (inches)
- ◆ Tolerance is $\pm 0.25\text{mm}(.010\text{'})$ unless otherwise noted.

Absolute maximum ratings($T_a=25^\circ\text{C}$)

Parameter	MAX.		Unit
Power Dissipation	E	50	mW
	G	50	
Peak Forward Current (1/10 Duty Cycle, 0.1ms Pulse Width)	100		mA
Continuous Forward Current	20		mA
Derating Linear From 50°C	0.4		mA/ $^\circ\text{C}$
Reverse Voltage	5		V
Operating Temperature Range	-30 $^\circ\text{C}$ to +80 $^\circ\text{C}$		
Storage Temperature Range	-40 $^\circ\text{C}$ to +100 $^\circ\text{C}$		
Lead Soldering Temperature[4mm(.157") From Body]	260 $^\circ\text{C}$ for 5 Seconds		

Electrical and optical characteristics(Ta=25 °c)

Parameter	Symbol	Min.	Typ.	Max.	Unit	Test Condition
Luminous Intensity	I _v	E	-	350	-	mcd
		G	-	200	-	
Viewing Angle	2θ _{1/2}	E	60	65	70	Deg
		G	60	65	70	
Peak Emission Wavelength	λ _p	E	625	630	635	nm
		G	563	568	573	
Dominant Wavelength	λ _d	E	620	625	630	nm
		G	567	572	577	
Spectral Line Half-Width	Δλ	E	10	15	20	nm
		G	15	20	25	
Forward Voltage	V _F	E	1.6	2.0	2.4	V
		G	1.8	2.3	2.8	
Reverse Current	I _R		-	50	uA	V _R =5V

Typical Electrical Characteristics Curves (25 °c Ambient Temperature Unless Otherwise Noted)

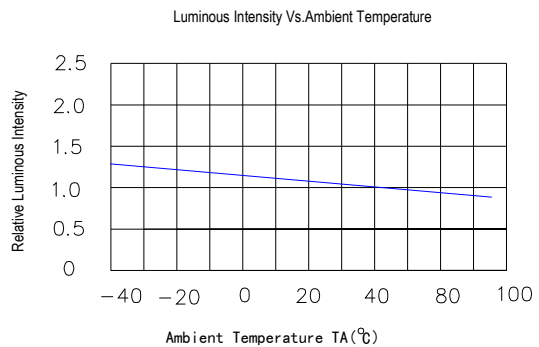
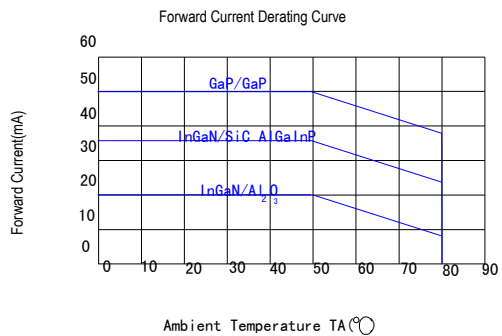
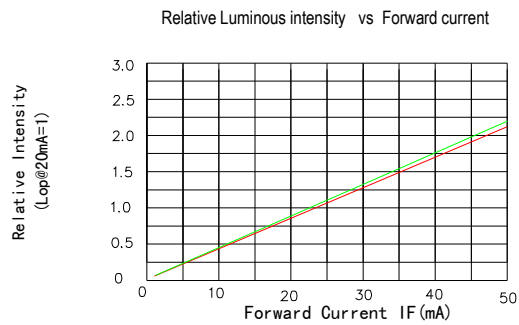
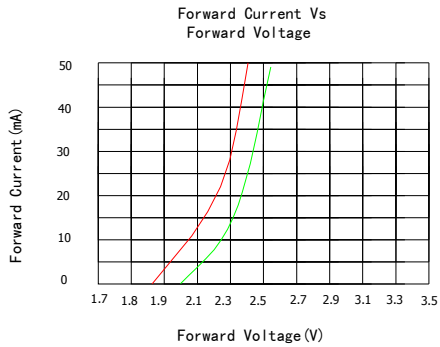
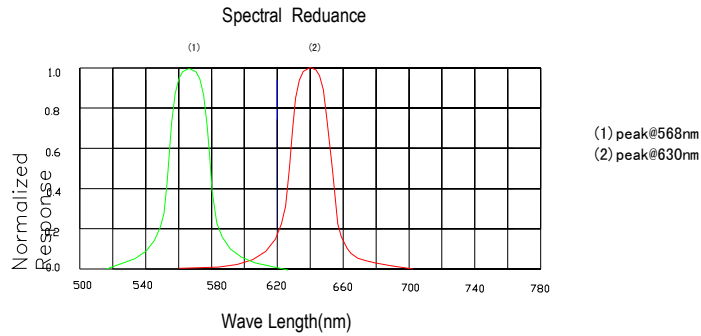

LAMP PACKING.

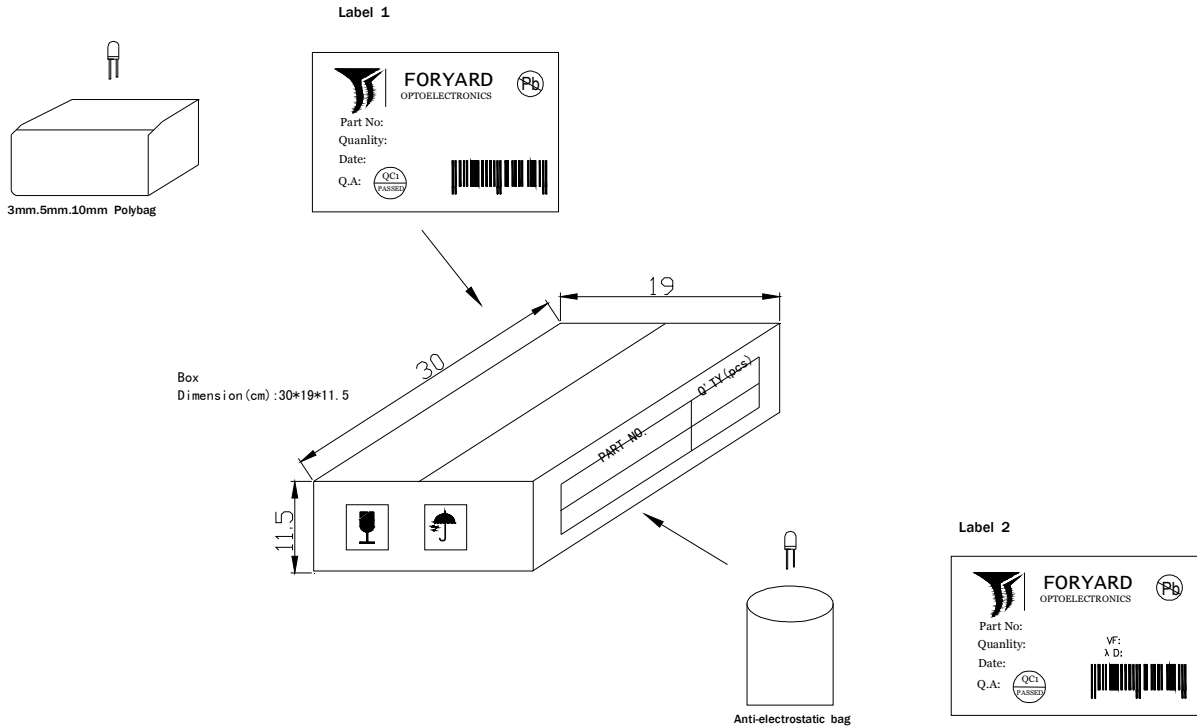

DEVICE	QTY/polybag(pcs)	Polybag/box A	Fig
5mm(T-1 3/4)	1000	8 bags	Label 1
3mm(T-1)	1000	10 bags	Label 1
10mm(T-1)	250	8 bags	Label 1
Blue/Green/White	500pcs	8 bags	Label 2

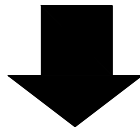

CARTON
Dimension(cm):39*32*38

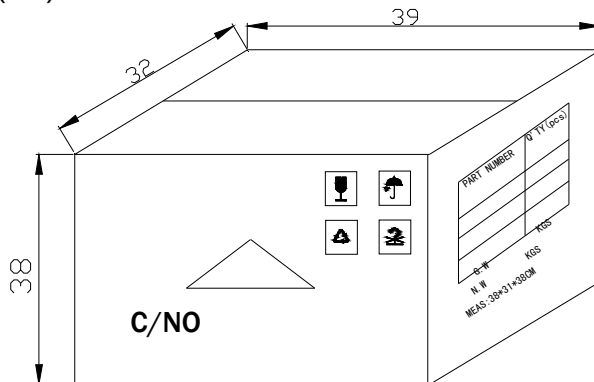

6 Boxes/Carton
 5mm:48,000pcs
 3mm:60,000pcs
 10mm:12,000pcs
 Blue/Pure Green/bluish Green
 /White:24,000pcs