

## FYL-3044HC1C

### Features:

- General purpose leads
- RoHs complant.

### Descriptions:

- Dice material: GaP
- Emitting Color: Red
- Device Outline:  $\Phi 3\text{mm}$  cylinder Type.
- Lens Type: water clear.

### Radiation pattern.

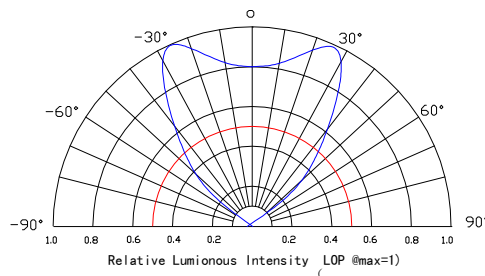

### Package configuration

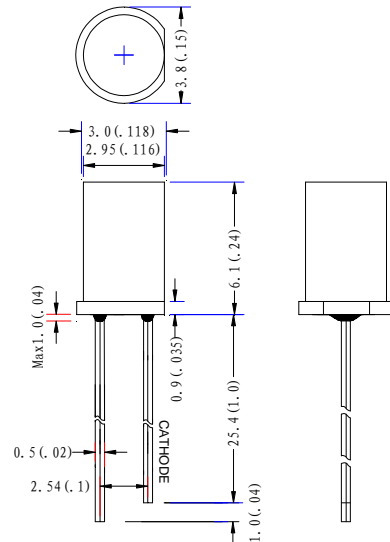

- ◆ All dimensions are millimeters (inches)
- ◆ Tolerance is  $\pm 0.25\text{mm}$  (.010") unless otherwise noted.

### Absolute maximum ratings( $T_a=25^\circ\text{C}$ )

Parameter	MAX.	Unit
Power Dissipation	50	mW
Peak Forward Current (1/10 Duty Cycle, 0.1ms Pulse Width)	100	mA
Continuous Forward Current	20	mA
Derating Linear From $50^\circ\text{C}$	0.4	mA/ $^\circ\text{C}$
Reverse Voltage	5	V
Operating Temperature Range	$-30^\circ\text{C}$ to $+80^\circ\text{C}$	
Storage Temperature Range	$-40^\circ\text{C}$ to $+100^\circ\text{C}$	
Lead Soldering Temperature[4mm(.157") From Body]	260 $^\circ\text{C}$ for 5 Seconds	

### Electrical and optical characteristics( $T_a=25^\circ\text{C}$ )

Parameter	Symbol	Min.	Typ.	Max.	Unit	Test Condition
Luminous Intensity	$I_v$	-	85	-	mcd	$I_F=20\text{mA}$
Viewing Angle	$2\theta_{1/2}$	80	90	100	Deg	
Peak Emission	$\lambda_p$	-	700	-	nm	
Dominant Wavelength	$\lambda_d$	-	660	-	nm	
Spectral Line Half-Width	$\Delta\lambda$	10	15	20	nm	
Forward Voltage	$V_F$	2.0	2.2	2.5	V	$V_R=5\text{V}$
Reverse Current	$I_R$			50	$\mu\text{A}$	

## Typical Electrical Characteristics Curves (25 °c Ambient Temperature Unless Otherwise Noted)

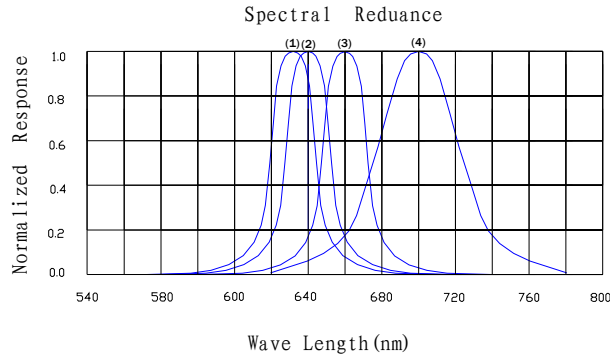

- (1) AlGaInP peak@630/Red
- (2) GaAsP/GaP peak@640nm /Red
- (3) AlGaAs/GaAs peak@660nm/Super Red
- (4) GaP peak@700nm/ Red

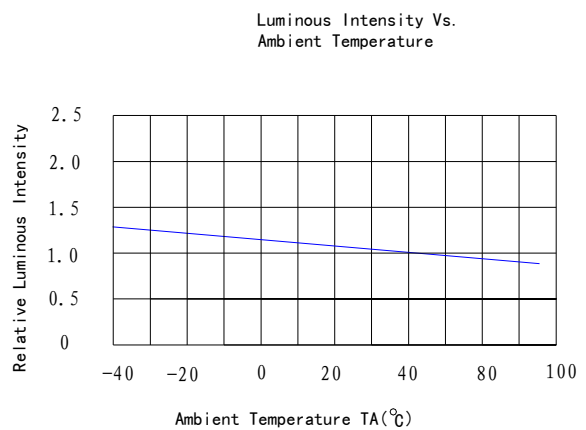
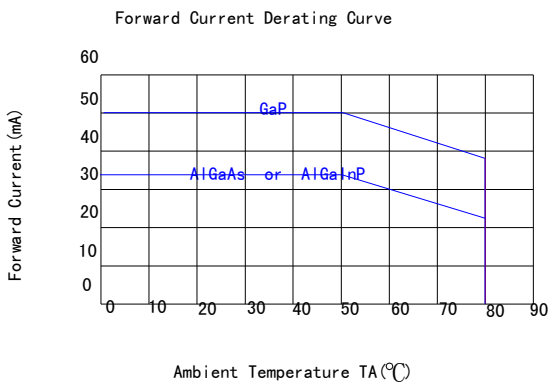
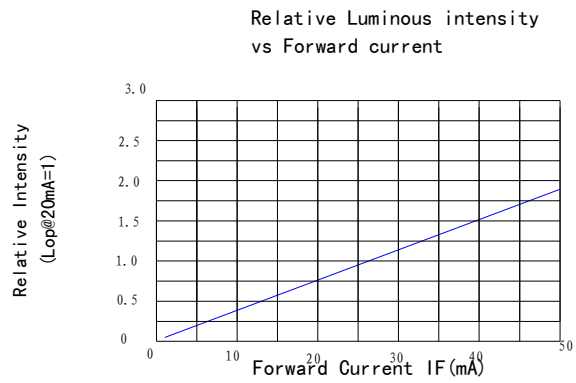
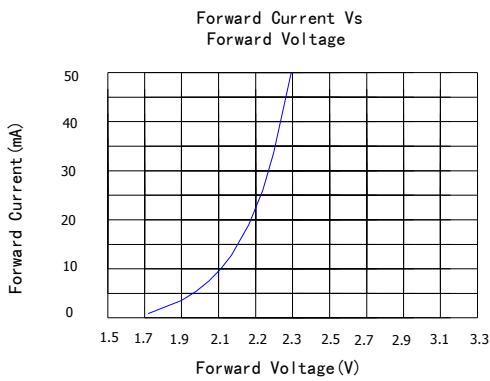

## LAMP PACKING.

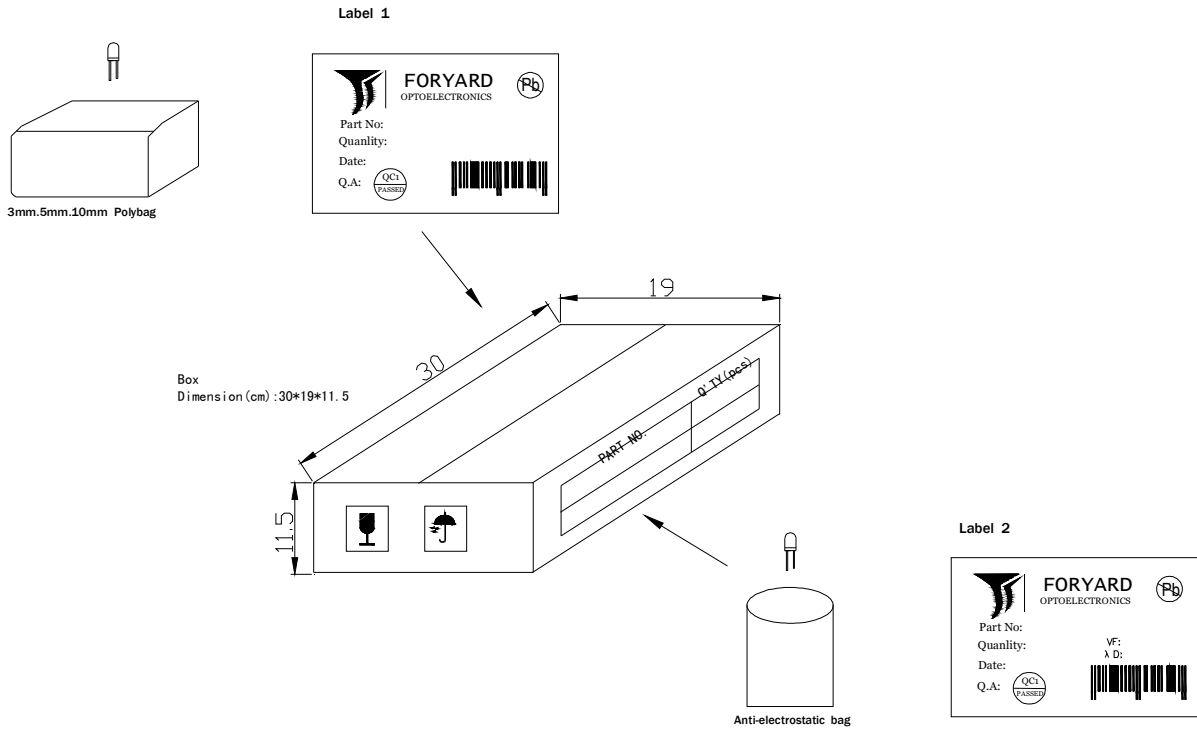

DEVICE	QTY/polybag(pcs)	Polybag/box A	Fig
5mm(T-1 3/4)	1000	8 bags	Label 1
3mm(T-1)	1000	10 bags	Label 1
10mm(T-1)	250	8 bags	Label 1
Blue/Green/White	500pcs	8 bags	Label 2

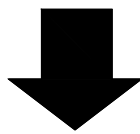

**CARTON**  
Dimension(cm):39\*32\*38

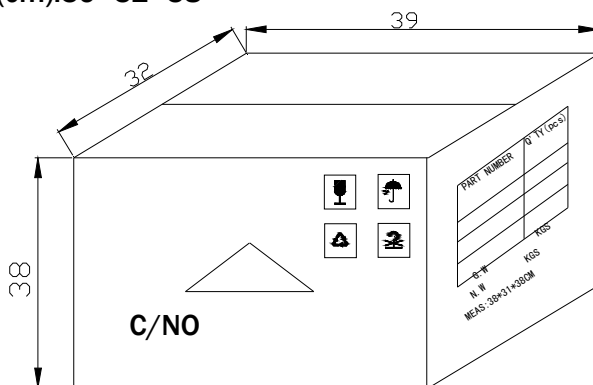

6 Boxes/Carton  
5mm:48,000pcs  
3mm:60,000pcs  
10mm:12,000pcs  
Blue/Pure Green/bluish Green  
/White:24,000pcs