

FYL-8033SUYC1A

Features:

- High intensity
- General purpose leads
- RoHs compliant.

Descriptions:

- Dice material: AlGaInP
- Emitting Color: Super bright yellow
- Device Outline: $\Phi 8\text{mm}$ Concave Type.
- Lens Type: Water clear

Radiation pattern.

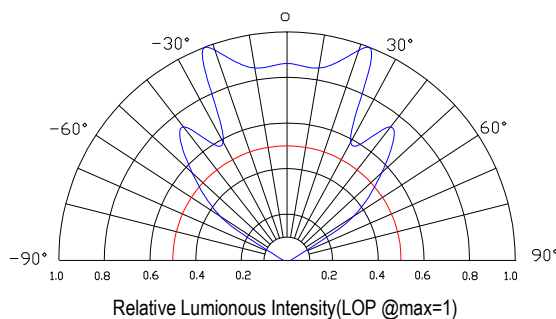

Package configuration

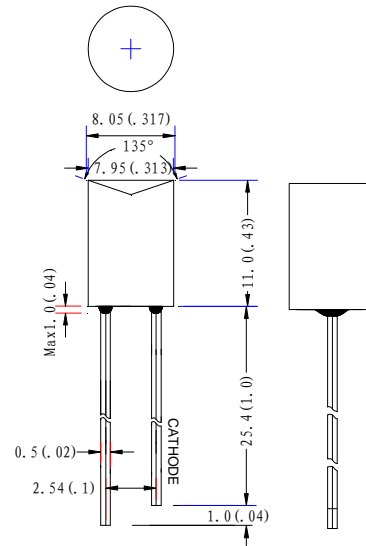

- ◆ All dimensions are millimeters (inches)
- ◆ Tolerance is $\pm 0.25\text{mm}$ (.010") unless otherwise noted.

Absolute maximum ratings($T_a=25^\circ\text{C}$)

| Parameter | MAX. | Unit |
|---|---|----------------------|
| Power Dissipation | 50 | mW |
| Peak Forward Current (1/10 Duty Cycle, 0.1ms Pulse Width) | 100 | mA |
| Continuous Forward Current | 20 | mA |
| Derating Linear From 50°C | 0.4 | mA/ $^\circ\text{C}$ |
| Reverse Voltage | 5 | V |
| Operating Temperature Range | -30°C to $+80^\circ\text{C}$ | |
| Storage Temperature Range | -40°C to $+100^\circ\text{C}$ | |
| Lead Soldering Temperature[4mm(.157") From Body] | 260 $^\circ\text{C}$ for 5 Seconds | |

Electrical and optical characteristics($T_a=25^\circ\text{C}$)

| Parameter | Symbol | Min. | Typ. | Max. | Unit | Test Condition |
|--------------------------|-----------------|------|------|------|---------------|-------------------|
| Luminous Intensity | I_v | - | 600 | - | mcd | $I_F=20\text{mA}$ |
| Viewing Angle | $2\theta_{1/2}$ | 100 | 110 | 120 | Deg | |
| Peak Emission | λ_p | 583 | 588 | 593 | nm | |
| Dominant Wavelength | λ_d | 585 | 590 | 595 | nm | |
| Spectral Line Half-Width | $\Delta\lambda$ | 15 | 20 | 25 | nm | |
| Forward Voltage | V_F | 1.9 | 2.1 | 2.3 | V | $V_R=5\text{V}$ |
| Reverse Current | I_R | | | 50 | μA | |

Typical Electrical Characteristics Curves (25 °c Ambient Temperature Unless Otherwise Noted)

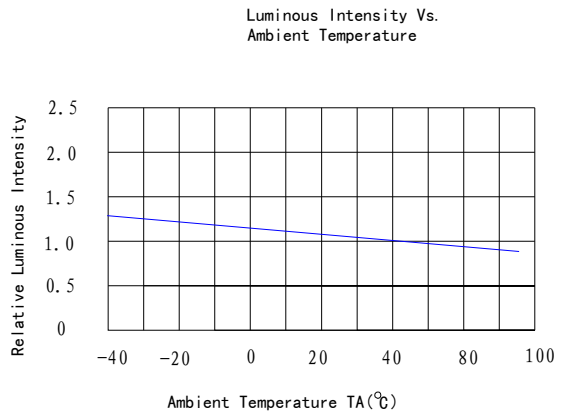
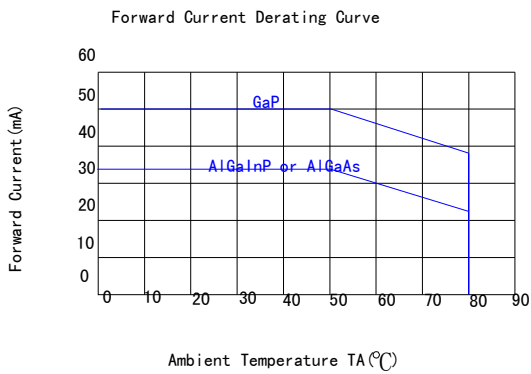
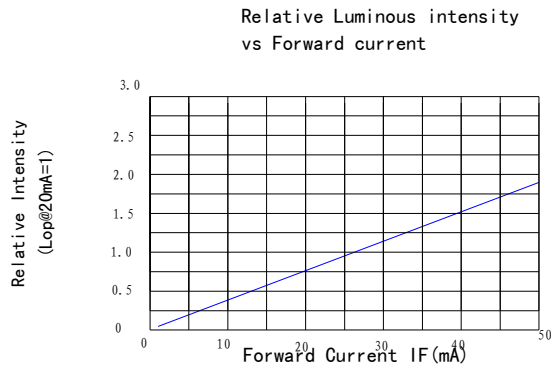
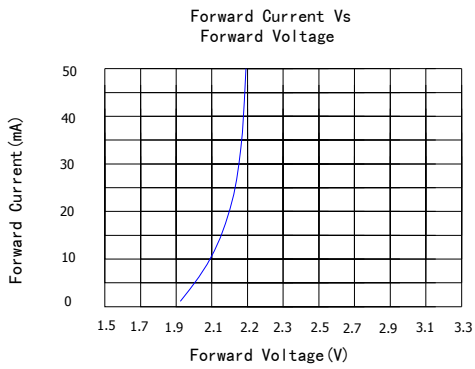
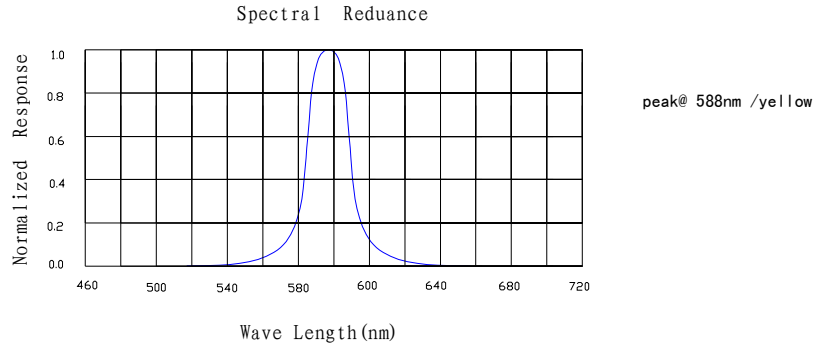

LAMP PACKING.

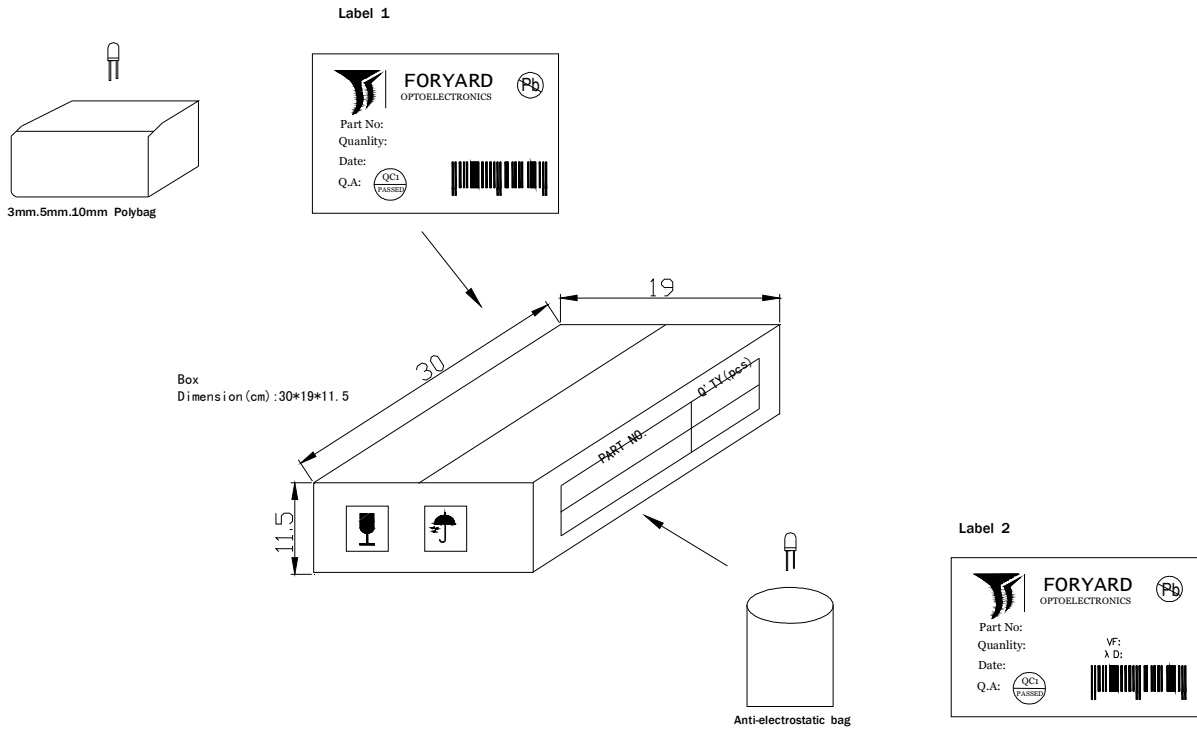

| DEVICE | QTY/polybag(pcs) | Polybag/box A | Fig |
|------------------|------------------|---------------|---------|
| 5mm(T-1 3/4) | 1000 | 8 bags | Label 1 |
| 3mm(T-1) | 1000 | 10 bags | Label 1 |
| 10mm(T-1) | 250 | 8 bags | Label 1 |
| Blue/Green/White | 500pcs | 8 bags | Label 2 |

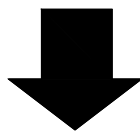

CARTON
 Dimension(cm):39*32*38

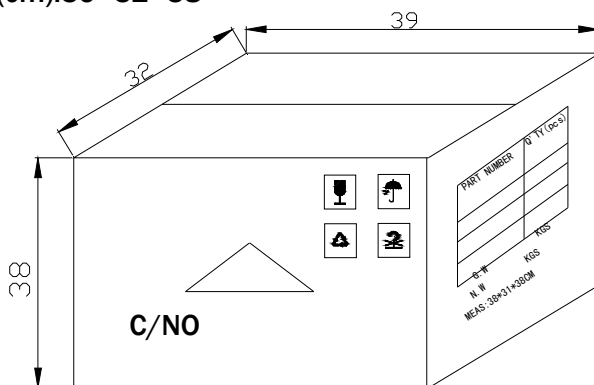

6 Boxes/Carton
 5mm:48,000pcs
 3mm:60,000pcs
 10mm:12,000pcs
 Blue/Pure Green/bluish Green
 /White:24,000pcs