

## FYLF- 1140UW1C

### Features:

- High intensity
- General purpose leads
- RoHs complant.

### Descriptions:

- Dice material: InGaN
- Emitting Color: White
- Lens Type: Water clear

### Radiation pattern.

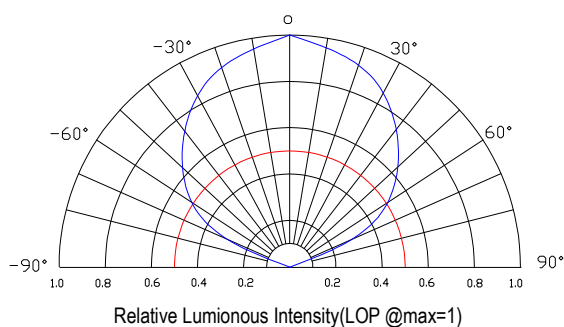

### Package configuration

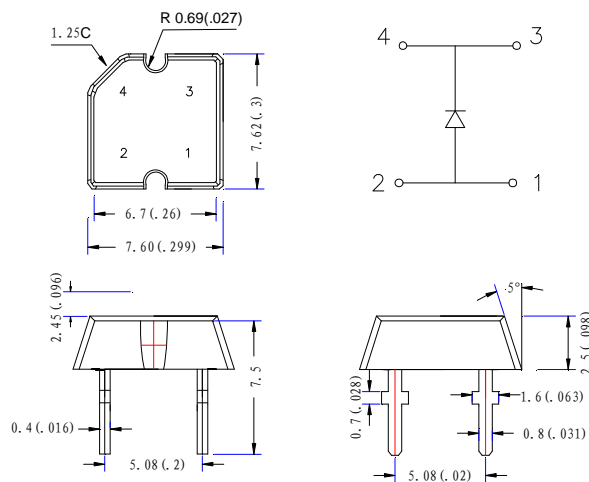

- ◆ All dimensions are millimeters (inches)
- ◆ Tolerance is  $\pm 0.25\text{mm}(.010")$  unless otherwise noted.

### Absolute maximum ratings( $T_a=25^\circ\text{C}$ )

Parameter	MAX.	Unit
Power Dissipation	70	mW
Peak Forward Current (1/10 Duty Cycle, 0.1ms Pulse Width)	100	mA
Continuous Forward Current	20	mA
Derating Linear From $50^\circ\text{C}$	0.4	mA/ $^\circ\text{C}$
Reverse Voltage	5	V
Electrostatic Discharge (ESD)	150	V
Operating Temperature Range	$-20^\circ\text{C}$ to $+80^\circ\text{C}$	
Storage Temperature Range	$-30^\circ\text{C}$ to $+100^\circ\text{C}$	
Lead Soldering Temperature[4mm(.157") From Body]	260 $^\circ\text{C}$ for 5 Seconds	

### Electrical and optical characteristics( $T_a=25^\circ\text{C}$ )

Parameter	Symbol	Min.	Typ.	Max.	Unit	Test Condition
Luminous Intensity	$I_v$	-	650	-	mcd	$I_F=20\text{mA}$
Viewing Angle	$2\theta_{1/2}$	110	120	130	Deg	
Chromaticiyt coordinates	x		0.30			
	y		0.31			
CCT			8000		K	
Forward Voltage	$V_F$	2.8	3.2	3.6	V	$V_R=5\text{V}$
Reverse Current	$I_R$			50	$\mu\text{A}$	

## Typical Electrical Characteristics Curves (25 °c Ambient Temperature Unless Otherwise Noted)

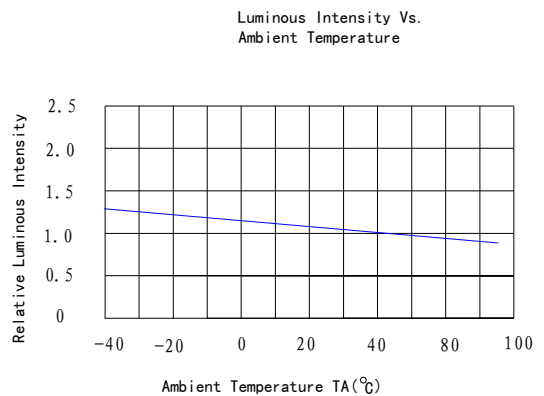
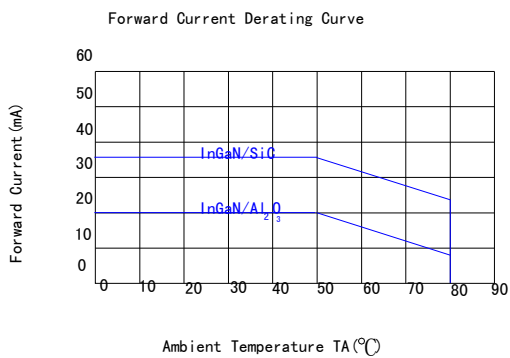
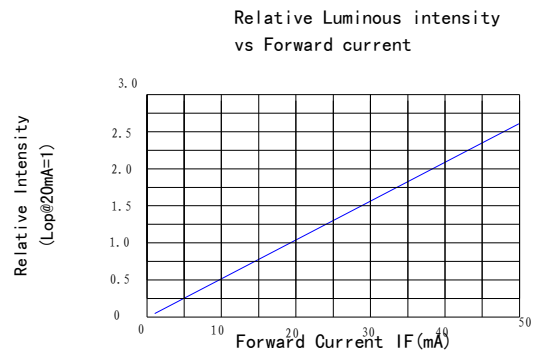
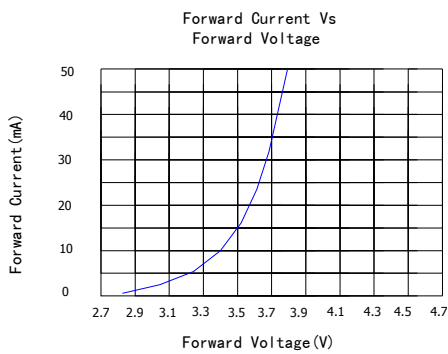
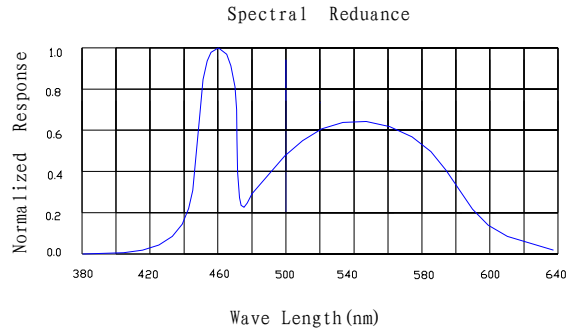

## Flux LEDs PACKING.

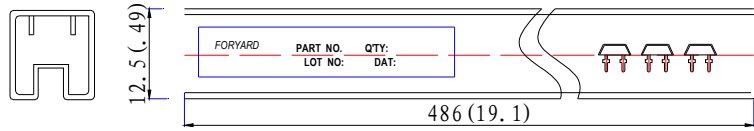
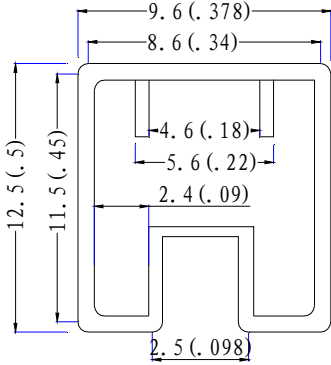

Adhesive Pipe  
Dimension:mm(inches)  
Each Adhesive Pipe 60 pcs

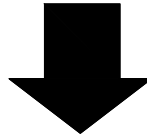

Box  
Dimension (cm) : 53\*15\*16.5

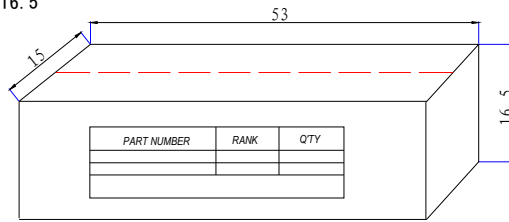

Each box/carotn 10,000pcs

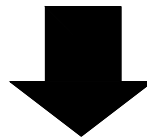

**CARTON**  
Dimension(cm):56\*32\*34.4

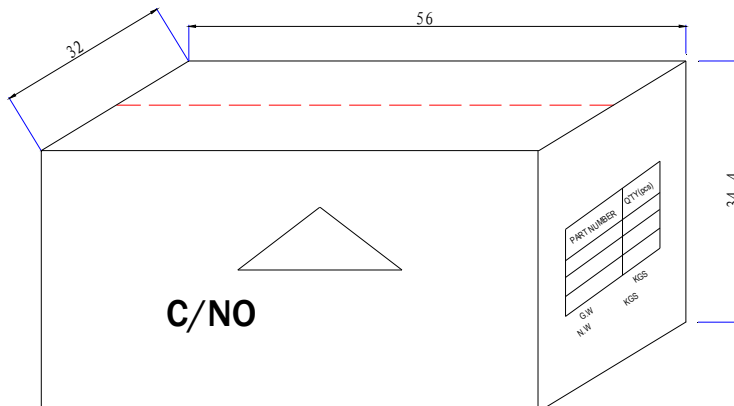

**4 Boxes/Carton**  
**Total :40,000pcs**