

FYLF- 1140UW4C

Features:

- High intensity
- General purpose leads
- RoHs compliant.

Descriptions:

- Dice material: InGaN
- Emitting Color: White
- Lens Type: Water clear

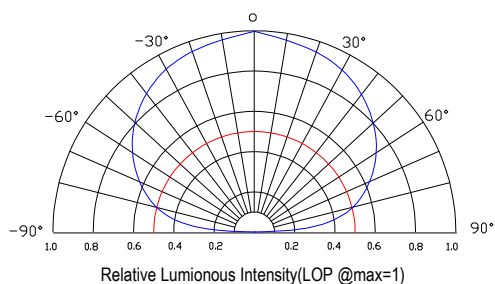

Package configuration

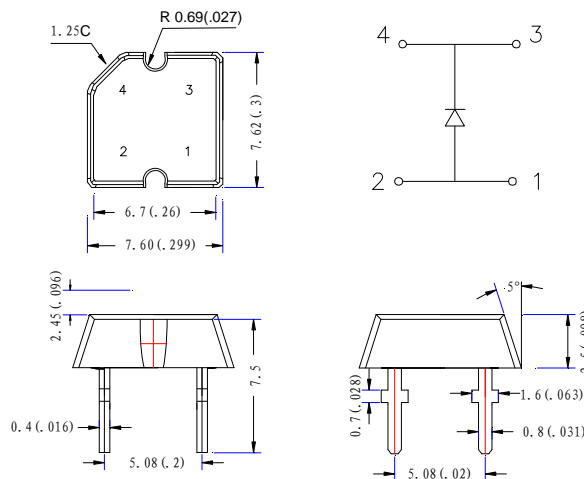

- ◆ All dimensions are millimeters (inches)
- ◆ Tolerance is $\pm 0.25\text{mm}(.010\text{'})$ unless otherwise noted.

Radiation pattern.

Absolute maximum ratings($T_a=25\text{ }^\circ\text{C}$)

Parameter	MAX.	Unit
Power Dissipation	300	mW
Peak Forward Current (1/10 Duty Cycle, 0.1ms Pulse Width)	400	mA
Continuous Forward Current	80	mA
Derating Linear From 50°C	0.4	mA/°C
Reverse Voltage	5	V
Electrostatic Discharge (ESD)	1000	V
Operating Temperature Range	-20°C to +80°C	
Storage Temperature Range	-30°C to +100°C	
Lead Soldering Temperature[4mm(.157") From Body]	260°C for 5 Seconds	

Electrical and optical characteristics($T_a=25\text{ }^\circ\text{C}$)

Parameter	Symbol	Min.	Typ.	Max.	Unit	Test Condition
Luminous Intensity	I_v	-	2000	-	mcd	$I_F=80\text{mA}$
Viewing Angle	$2\theta_{1/2}$	-	160	-	Deg	
Chromaticity coordinates	x		0.30			
	y		0.31			
CCT			8000		k	
Forward Voltage	V_F	2.8	3.2	3.6	V	
Reverse Current	I_R			10	μA	$V_R=5\text{V}$

Typical Electrical Characteristics Curves
(25 °c Ambient Temperature Unless Otherwise Noted)

Forward Current vs. Ambient Temperature

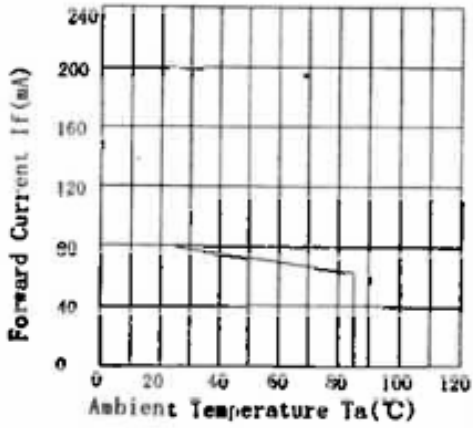

Relative Intensity vs. Ambient Temperature

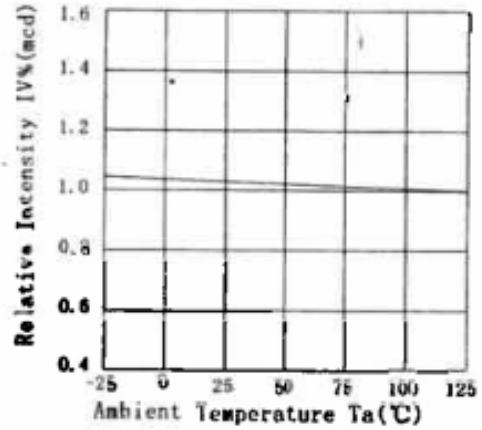

Forward Current vs. Forward Voltage

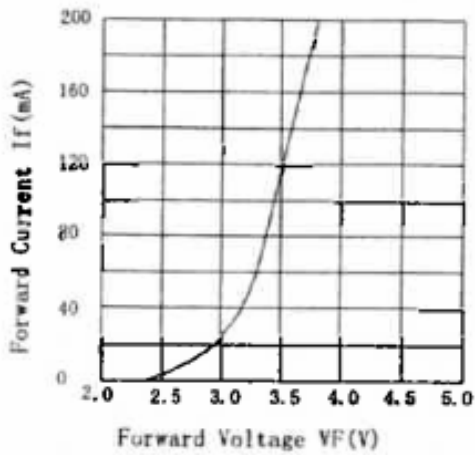

Forward Voltage vs. Ambient Temperature

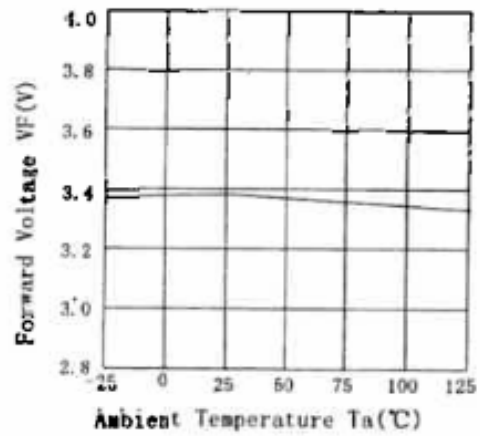

Flux LEDs PACKING.

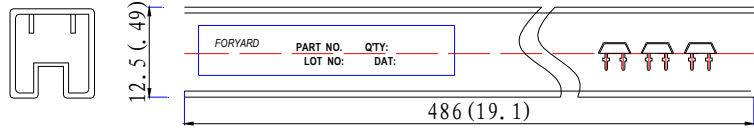
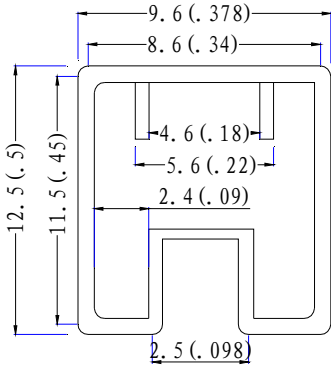

Adhesive Pipe
Dimension:mm(inches)
Each Adhesive Pipe 60 pcs

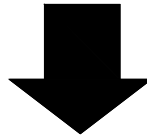

Box
Dimension (cm) : 53*15*16.5

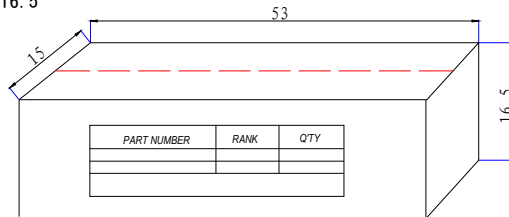

Each box/carotn 10,000pcs

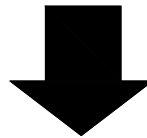

CARTON
Dimension(cm):56*32*34.4

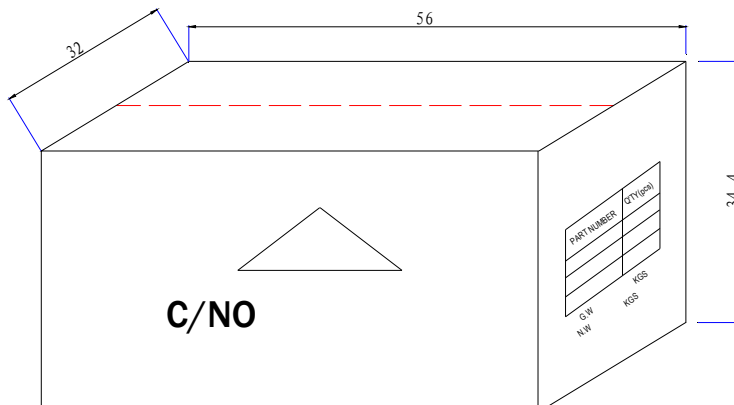

4 Boxes/Carton
Total :40,000pcs