

Model. No.	FYLP-5W-UWS-A
Rev.	A

PRODUCT SPECIFICATION

Model No.: FYLP-5W-UWS-A

Features:	
<ul style="list-style-type: none"> ■ High-Power LED Type ■ Size (mm):Φ5.6*8.5 concave ■ Emitting Color:White ■ SMT package ■ RoHS Compliant 	

Applications:
<ul style="list-style-type: none"> ■ Decorative lighting ■ Architectural lighting ■ Interior automotive ■ Illuminations



CUSTOMER APPROVED SIGNATURES	APPROVED BY	CHECKED BY	PREPARED BY

Model. No.	FYLP-5W-UWS-A
Rev.	A

Model No.: FYLP-5W-UWS-A

■ Mechanical Dimensions

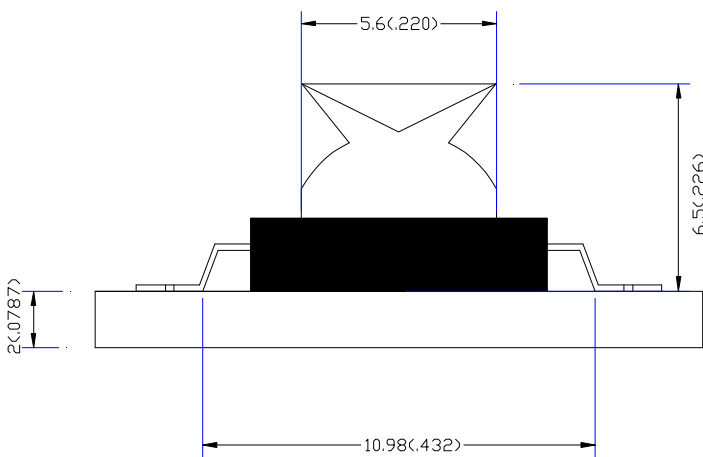
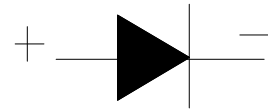
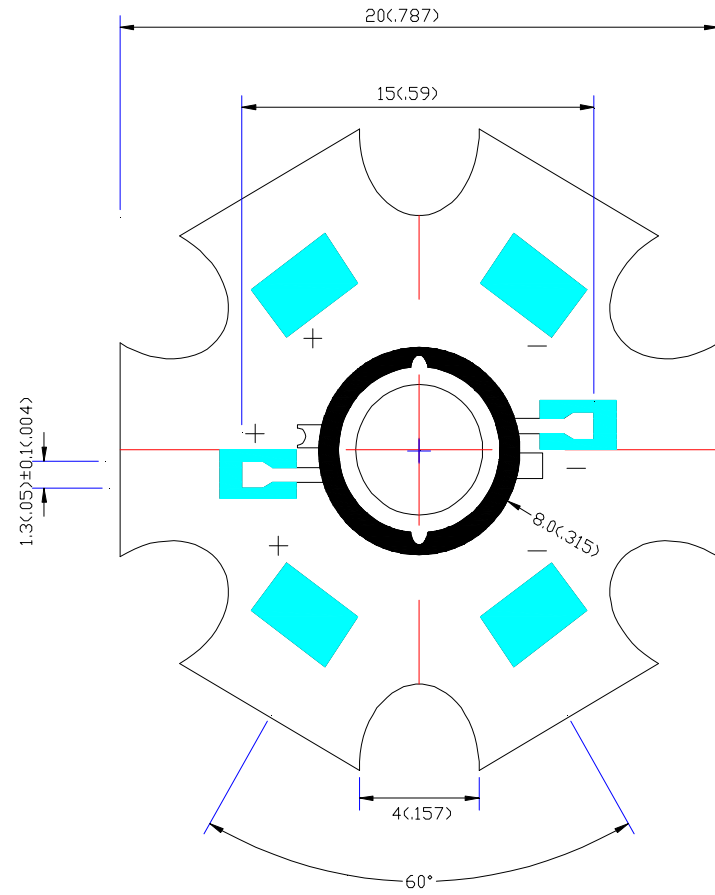

Notes:

1. Dimension in millimeter, tolerance is ±0.2mm.

3. The specifications, characteristics and technical data described in the datasheet are subject to change without prior notice.

Model. No.	FYLP-5W-UWS-A
Rev.	A

Model No.: FYLP-5W-UWS-A

■ Absolute Maximun Ratings(Ta=25° C)

Items	Symbol	Absolute maximum Rating	Unit
Forward Current(DC)	IF	1200	mA
Peak Forward Current*	IFP	1300	mA
Power Dissipation	PD	5000	Mw
Operation Temperature	Topr	-40° C+85° C	°C
Storage Temperature	Tstg	-40°C+100°C	°C
Reverse Voltage	VR	5	V
Soldering Temperature	Tsol	Reflow Soldering:260°C/3sec	

*Pulse width \leq 1msec duty \leq 1/10

■ Typical Electrical &Optical Charcteristics(Ta=25°C)

Items	Symbol	Condition	Min.	Typ.	Max	Unit
Forward Voltage	VF	IF =1200mA	2.8	---	3.6	V
Reverse Current	IR	VR = 5V			5	uA
Chromatic Coordinates	(X,Y)	IF =1200mA	---	(0.34,0.38)	---	---
Color Temperature	CCT	IF =1200mA	5000	---	6000	K
Luminous Flux	Φ V	IF =1200mA	---	200	---	LM
50% Power Angle	2 θ ½	IF =1200mA	---	120	---	Deg

■ Material

Item	Reflector	Wire	Encapsulate	Chip
Material	PPA	Gold	Silicone	InGaN

Note:

- 1.Luminous Intensity is based on the Foryard standards.
- 2.Pay attention about static for InGaN

Model. No.	FYLP-5W-UWS-A
Rev.	A

Model No.: FYLP-5W-UWS-A

Typical Eletrical/Optical Characteristics Curves(Ta=25° C Unless Otherwise Noted)

Spectral Reduance

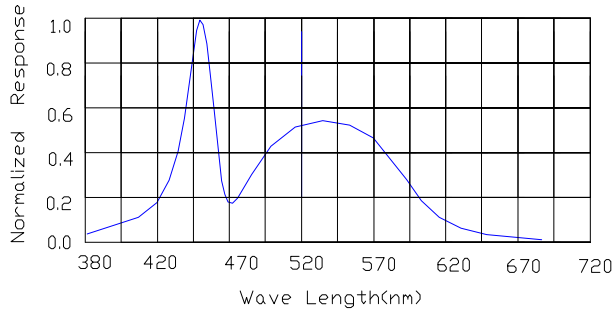

Forward Current Vs Forward Voltage

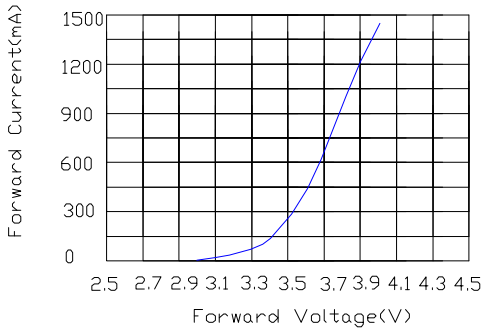

Relative Luminous intensity vs Forward current

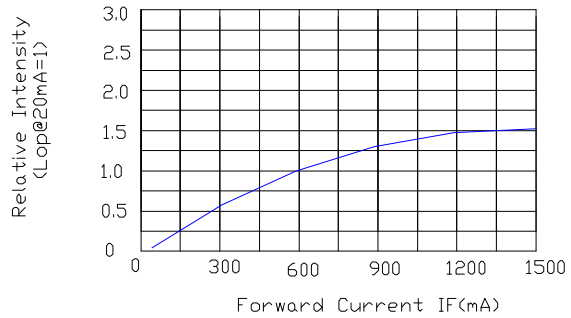

Forward Current Denating Curve

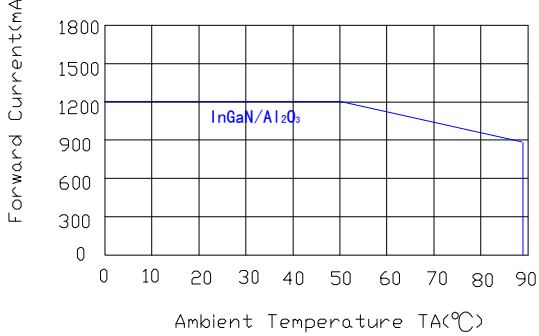

Luminous Intensity Vs. Ambient Temperature

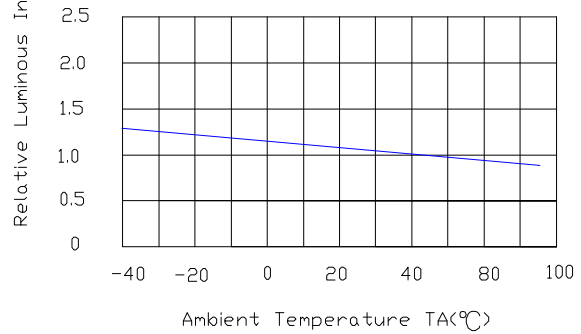

Radiation pattern.

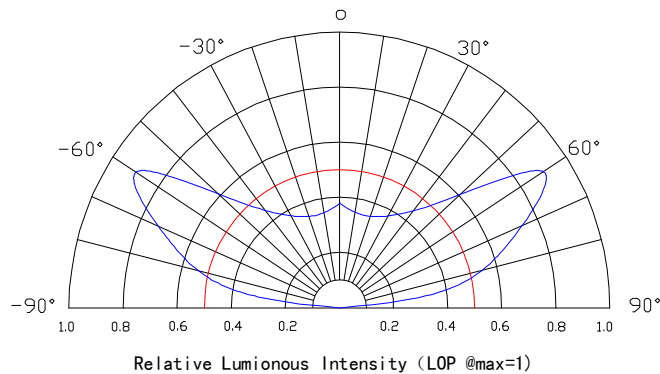

Model. No.	FYLP-5W-UWS-A
Rev.	A

Model No.: FYLP-5W-UWS-A

■ Packing Diagram

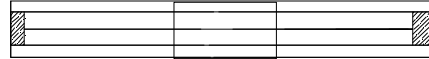

20PCS/Reel

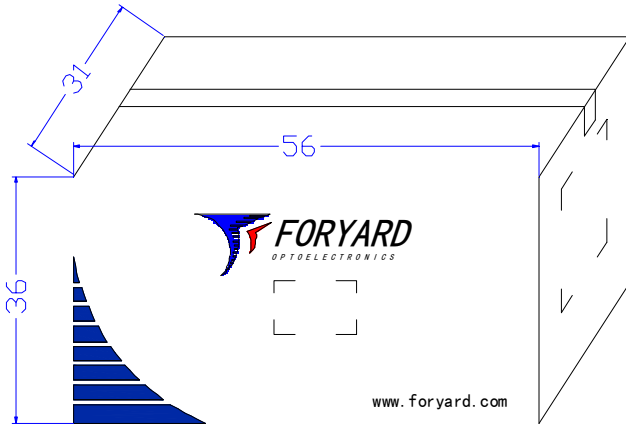
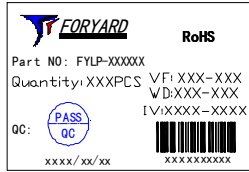

6 Boxes/Carton

OUTSIDE LABEL

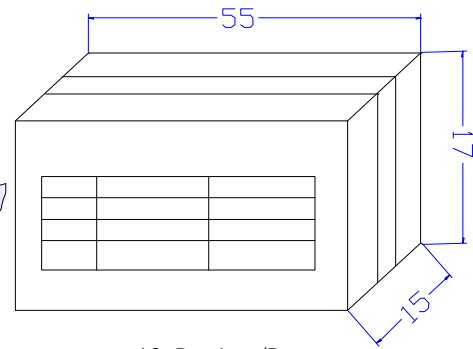

10 Reels /Box

OUTSIDE LABEL

Model. No.	FYLP-5W-UWS-A
Rev.	A

Model No.: FYLP-5W-UWS-A

■ Precautions for use:

1. Storage

To prevent moisture absorption into High-power LEDs during the transportation and storage , the LEDs are pack in a moisture-barrier bag. Desiccants and a humidity indicator are packed together with the LEDs as secondary protection

The shelf life of LEDs stored in the original sealed bag at <math> < 40^{\circ}\text{C}</math> and <math> < 90\% \text{ RH}</math> is 12 months. Baking is required if the shelf life has expired

Before opening the packaging , check for air leaks in the bag.

After the bag is opened, the High-power LEDs must be stored at <math> < 30^{\circ}\text{C}</math> and <math> < 60\% \text{ RH}</math>. Under these conditions, High-power LEDs must be used within 24 hours. If the LEDs are not within 24 hours after removal from the bag baking is required Take the material out of the packaging bag before baking. Do not open the oven door frequently during the baking process.

2. Soldering

(1) Manual soldering with a soldering Iron

Use a soldering iron of less than 25 watts is recommended . The iron temperature must be kept below 315°C And soldering time no more than 2 seconds.

The epoxy resin of an High-power LED should not contact the tip of the soldering iron.

No mechanical stress should be exerted on the resin portion of an High-power LED during soldering.

Handling of an High-power LED should be done only when the package has been cooled down to below 40°C

(2)Reflow soldering

Temperature profile

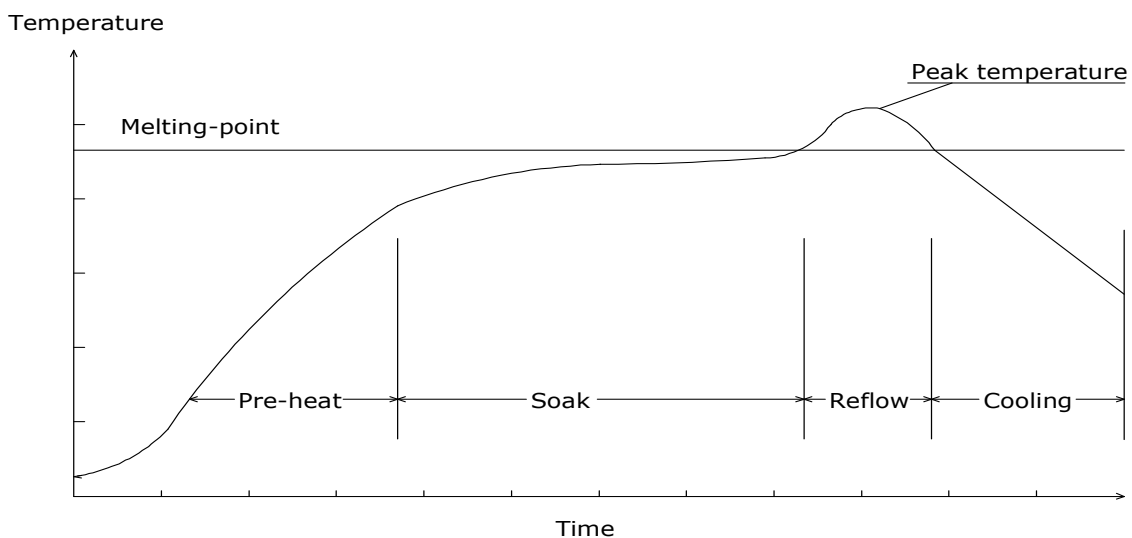

Model. No.	FYLP-5W-UWS-A
Rev.	A

Model No.: FYLP-5W-UWS-A

Solder=Sn63-Pb37	Solder= Pb-Free
Average ramp-up rate:4°C/sec.max	Average ramp-up rate:4°C/sec.max
Peak preheat temperature:100-150°C	Peak preheat temperature:100-150°C
preheat time:100seconds.max	preheat time:100seconds.max
ramp-down rate:6°C/sec.max	ramp-down rate:6°C/sec.max
Peak temperature:230°C	Peak temperature:250°C
Time within 5°C of actual peak temperature=10 sec. max	Time within 5°C of actual peak temperature=10 sec. max
Duration above 183°C is 80 sec. max	Duration above 217°C is 80 sec. max

High-power LED should not be modified after soldering. If modification cannot be avoided, the modification must be pre-qualified to avoid damage to the High-power LEDs.

Reflow soldering should not be done more than one time

No stress should be exerted on the package during soldering.

3. Static Electricity

Static Electricity and surge voltage damage the LEDs. So it is recommended that an ESD wrist band, ESD shoe strap or an anti-electrostatic glove be used when handling the LEDs.

All devices, equipment and machinery must be properly grounded

4. Others

Reverse voltage should not exceed the absolute maximum rating on the data sheet. The colour of the LEDs is changed slightly an operating current and thermal.

This device should not be used in any type of fluid such as water, oil, organic solvent and etc

When washing is required, IPA (Isopropyl Alcohol) should be used.

The influence of ultrasonic cleaning on the leds depends on factors such as ultrasonic power and the way.

High-brightness LED light may injure human eyes. Avoid looking directly into lighted LED

The appearance and specifications of the product may be modified for improvement without notice.