

FYLS-0805LRC

Features:

- Compatible with automatic placement equipment
- Compatible with reflow solder process.

Applications:

- Automotive-Telecommunication
- Indicators
- Lcd Back-lights
- Illuminations

Descriptions:

- Dice material: AlGaAs.
- Emitting Color: high Red.
- Lens Color: Water clear.

Radiation pattern.

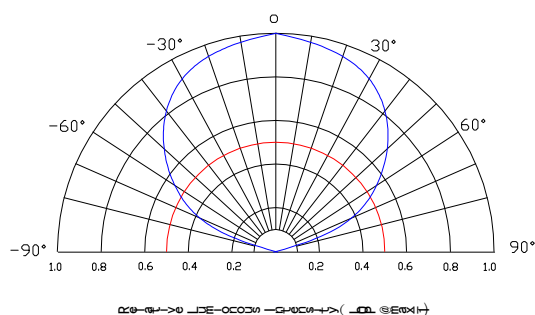

Absolute maximum ratings(Ta=25 °c)

Parameter	MAX.	Unit
Power Dissipation	78	mW
Peak Forward Current (1/10 Duty Cycle, 0.1ms Pulse Width)	100	mA
Continuous Forward Current	30	mA
Derating Linear From 25°C	0.4	mA/°C
Operating Temperature Range	-30°C to +80°C	
Storage Temperature Range	-40°C to +85°C	

Electrical and optical characteristics(Ta=25 °c)

Parameter	Symbol	Min.	Typ.	Max.	Unit	Test Condition
Luminous Intensity	IV	-	13	-	mcd	IF=20mA
Viewing Angle	2θ1/2	-	130	-	Deg	
Peak Emission Wavelength	λp	-	660	-	nm	
Dominant Wavelength	λd	-	643	-	nm	
Spectral Line Half-Width	Δλ	25	30	35	nm	
Forward Voltage	VF		1.9	2.3	V	
Reverse Current	IR			10	μA	VR=5V

Typical Electrical Characteristics Curves (25 °c Ambient Temperature Unless Otherwise Noted)

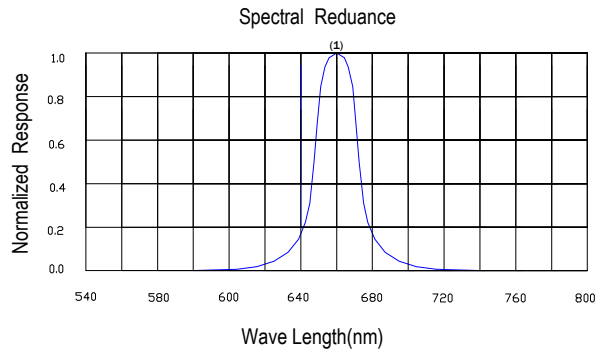

(1)AlGaN P peak@660/Red

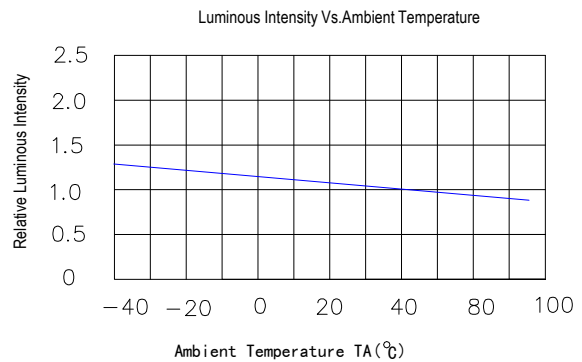
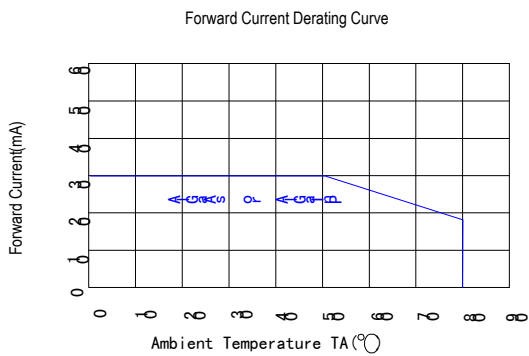
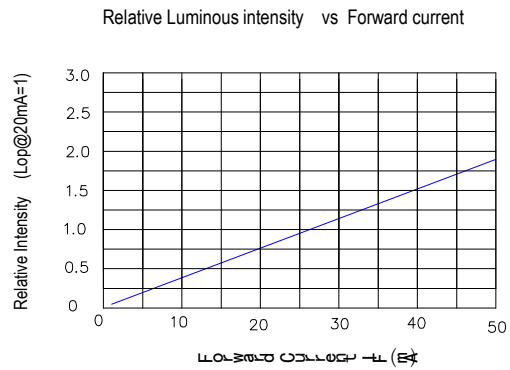
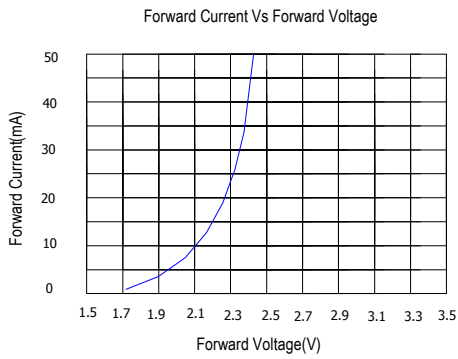

◆ Precautions For Use

1. Suggest the LEDs should be kept between 5°C and 30°C and 60%RH or less before opening the package, The max. storage period before opening the package is 1 year.
2. After opening the package, the LEDs should be kept at 30°C/35%RH or less, and it should be used within 3 hours. In the event of incomplete usage, it is advised that user preheat the remaining devices at 60±5°C for 8 hours prior to use.
3. Reflow soldering should not be done more than twice. When soldering, don't tress on LEDs during heating. After soldering, don't warp the circuit board.
4. Repair should not be done after the LEDs have been soldered. When repair is unavoidable, Double-head soldering iron should be used. It should be confirmed beforehand whether the characteristics of the LEDs will be damaged by repair or not.

◆ Soldering Iron:

- Temperature at tip of iron: 300 °c Max.(25W Max)
- Soldering time: 3±1sec.

◆ Reflow Temp./Time:

Please refer to the following figure :

Temp.(°C)		Time(Sec)	
a	25	T0~T1	Max. 3°C/sec
b	150	T1~T2	90~130 sec
c	200	T2~T3	Max. 3°C/sec
d	220	T3~T4	Max. 30~50 sec
e	250		
		T4~T5	Max. -3°C/sec
Blet Speed		70~90 cm/min	

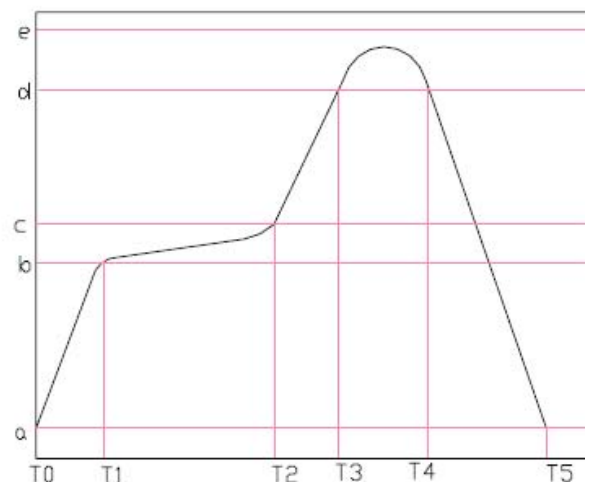

◆ Package Dimensions of Device

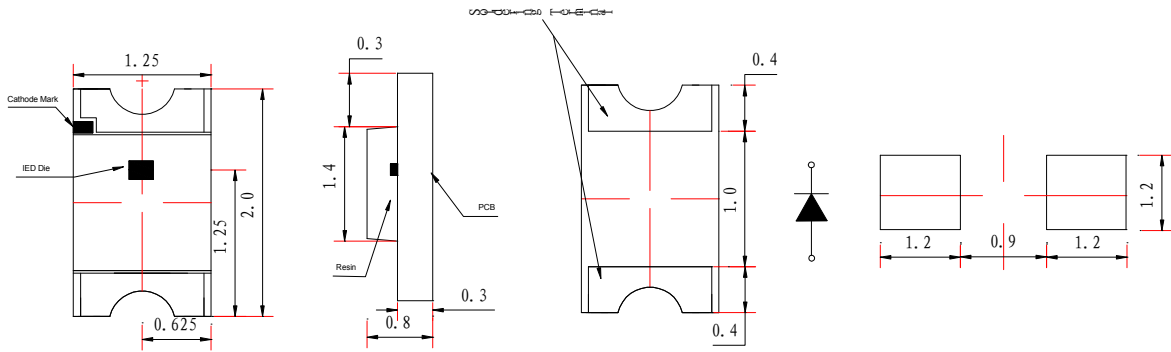

Unit:mm

◆ Tape Specification: 4000pcs Per Reel.

Packing Size								
Item	W	P1	E	F	D0	D1	P0	Unit
Spec.	8.00	4.00	1.75	3.50	1.50	1.0	4.00	mm
Tolerance	±0.20	±0.10	±0.10	±0.05	+0.1/-0	±0.05	±0.05	mm
Item	10P0	P2	A0	B0	K0	T		Unit
Spec.	40.00	2.00	1.40	2.25	1.1	0.23		mm
Tolerance	±0.20	±0.05	±0.10	±0.10	±0.10	±0.05		mm

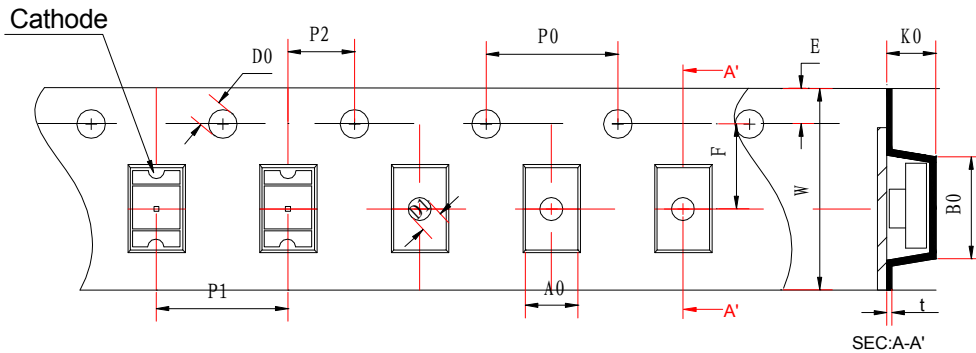

◆ Package Dimensions of Reel:

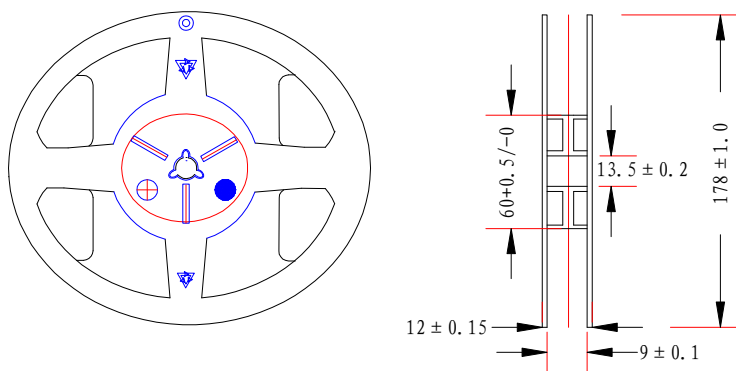

Unit:mm

◆ Packing and Shipping Spec.

